

Fire Safety Engineering Design of Combustible Façades

Prepared for

Forest & Wood Products Australia

by

Exova Warringtonfire Aus Pty Ltd



**Forest & Wood
Products Australia**
Knowledge for a sustainable Australia



Publication: Fire Safety Engineering of Combustible Façades

Project No: PNA217-1011

© 2011 Forest & Wood Products Australia Limited. All rights reserved.

Forest & Wood Products Australia Limited (FWPA) makes no warranties or assurances with respect to this publication including merchantability, fitness for purpose or otherwise. FWPA and all persons associated with it exclude all liability (including liability for negligence) in relation to any opinion, advice or information contained in this publication or for any consequences arising from the use of such opinion, advice or information.

This work is copyright and protected under the Copyright Act 1968 (Cth). All material except the FWPA logo and the Exova Warringtonfire logo may be reproduced in whole or in part, provided that it is not sold or used for commercial benefit and its source (Forest & Wood Products Australia Limited and Exova Warringtonfire) is acknowledged. Reproduction or copying for other purposes, which is strictly reserved only for the owner or licensee of copyright under the Copyright Act, is prohibited without the prior written consent of Forest & Wood Products Australia Limited.

ISBN: 978-1-921763-32-8

Researchers:

Paul England, Matthew Eyre
Exova Warringtonfire Aus Pty Ltd
Unit 2
409-411 Hammond Road
Dandenong
Victoria, 3175
Australia

Report Issue Number: 1
Report Issue Date: 24/5/2011

This is not the final report.

Forest & Wood Products Australia Limited
Level 4, 10-16 Queen St, Melbourne, Victoria, 3000
T +61 3 9927 3200 F +61 3 9927 3288
E info@fwpa.com.au
W www.fwpa.com.au



Executive Summary

Architects are increasing the use of sustainable materials in the design of building façades. This presents challenges to regulators since the existing deemed-to-satisfy requirements in the National Construction Code Series (formerly Building Code of Australia) may be considered inappropriate. However external wall systems which are not properly designed and implemented can create a high risk of fire spread.

Controlling fire spread in a building can increase the time available for occupant evacuation, decrease fire losses and aid fire fighters in evacuating occupants and efficiently fighting the fire as well increase the time available to reduce fire spread to higher floors and adjacent buildings. The risk of fire spread to or from an adjacent building is further exacerbated by the trend to construct buildings at higher density.

This guideline provides methods, data and references which may be used by a Fire Safety Engineer while analysing a trial fire safety design that comprises of combustibile external wall cladding.

Table of Contents

Executive Summary	i
1 Introduction	1
1.1 Historical fire record.....	1
1.2 Overview of fire engineering process.....	1
1.3 Fire scenarios involving external wall.....	2
1.4 Guideline format.....	2
2 Fire spread from external fire sources.....	3
2.1 Overview	3
2.2 Applied actions and design fires.....	3
2.2.1 Large hazards	3
2.2.2 Intermediate hazards	4
2.2.3 Smaller hazards	4
2.2.4 Adjacent Structures	4
2.2.5 Flame contact / exposure check and calculations.....	6
2.2.6 Radiant heat exposure calculations	6
2.3 Determination of performance by calculation	7
2.4 Determination of performance by tests	7
2.4.1 Radiant heat only.....	7
2.4.2 Full flame engulfment from large flaming sources.....	7
2.4.3 Intermediate scale façade test for evaluation of fire spread over combustible materials	8
2.5 Typical performance criteria	8
2.5.1 Resistance to horizontal fire spread through external wall fabric.....	8
2.5.2 Resistance to flame spread on external wall	9
2.5.3 Resistance to vertical fire spread through openings in external wall.....	9
3 Fire and smoke spread from internal fires.....	11
3.1 Overview	11
3.2 Applied actions and design fires.....	11
3.2.1 Fire load.....	12
3.2.2 Ventilation.....	12
3.2.3 Time-Temperature correlations.....	12
3.2.4 Fire severity calculations.....	13
3.2.5 External fire plume calculations.....	13
3.3 Determination of performance by calculation	13
3.3.1 Elements and combinations of elements exposed to a fully developed fire in a compartment.....	13
3.3.2 External elements or combinations of elements exposed to radiant heat and / or flames from a fully developed fire	14
3.4 Determination of performance by tests	14
3.5 Typical performance criteria	15
3.5.1 Resistance to fire spread between floors via external openings.....	15
3.5.2 Resistance to fire spread between floors due to fire spread across a combustible external façade.....	16
3.5.3 Resistance to fire spread via non-fire stopped concealed spaces.....	16
3.5.4 Resistance to fire spread between floors via openings between floors and the external wall	16
4 Fire spread to adjacent structures	17
4.1 Overview	17
4.2 Applied actions and design fires.....	17

4.2.1	Compartment fire and external flames	17
4.2.2	Contribution from façade material	17
4.3	Determination of performance by calculation	17
4.4	Determination of performance by tests	17
4.5	Typical performance criteria	17
5	Acknowledgements	19
Appendix A	Full scale test method (ISO 13785-2).....	21
Appendix B	Report of full scale tests	24

1 Introduction

This document provides advice on designing combustible external wall systems (façades) and guidance on analysing the system's performance in relation to vertical fire spread within a building and fire spread to and from adjacent buildings.

This guide is intended to complement the International Fire Engineering Guidelines¹ (IFEG) or other general fire engineering approaches by providing information on design and verification methods that may be suitable for the fire engineering design of the external façades of buildings and does not preclude the use of other acceptable methods.

Intended users are Fire Safety Engineers, regulators and approval authorities experienced in the use of Fire Safety Engineering approaches to determine compliance of performance based designs with building regulations and other design objectives.

Note: It is the responsibility of the Fire Safety Engineer undertaking the design to independently judge the suitability of any design method and input data for a particular application and that of the approval authority to check and agree the methodology and inputs are appropriate.

Section 1.1 of this document provides a brief overview of the historical record of fires involving vertical fire spread in high-rise buildings. Section 1.2 provides an overview of the Fire Safety Engineering process which sets the context in which this document should be used. The fire scenarios which are considered by this document are given in section 1.3. Section 1.4 describes the format of the rest of the document.

1.1 Historical fire record

Most historic and current prescriptive building codes limit the use of combustible façades in multi storey buildings. This may explain why there are not many fires reported which involved contribution from combustible cladding to vertical fire spread.

A review of fires in high rise building where the fire spread vertically can be found in the Fire Code Reform Centre report² and a paper by O'Conner³ and other sources.

1.2 Overview of fire engineering process

The IFEG like many other national and international guidelines and codes state that the typical fire engineering process normally goes through a number of processes. Figure 1-1 below is a typical example based on IFEG.

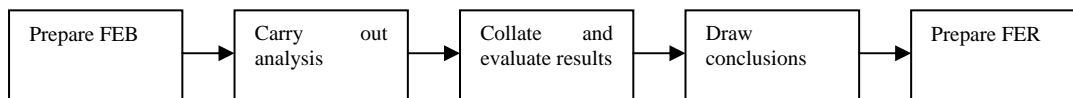

Figure 1-1 - Typical fire engineering process as described by IFEG

The Fire Engineering Brief (FEB) is a process that defines the scope of work for the fire engineering analysis and allows for stakeholder consultation culminating in a document that provides general details of the proposed design, methods of analysis and design actions (fire scenarios), verification methods and acceptance criteria.

¹ International Fire Engineering Guidelines, Australian Building Codes Board, 2005

² Fire Performance of Exterior Claddings, FCRC PR 00-03, Fire Code Research Reform Program, 2000

³ O'Conner, Building Façade or Fire Safety Façade, CTBUH 8th World Congress, 2008

1.3 Fire scenarios involving external wall

For convenience three main types of fire scenario have been identified that are common to most projects and a section of this guide has been dedicated to each of these scenarios.

This grouping of scenarios is for convenience and may not cover all relevant scenarios for all projects. The Fire Safety Engineer and approval authorities will need to make a decision on a case by case basis as to which fire scenarios are appropriate for use in the analysis.

Table 1 - fire scenarios

Fire Scenario	Brief Description	Section
Fire spread from external fire sources	This includes adjacent structures and other fire sources such as vehicles, waste materials and exposures caused by future developments.	2
Fire and smoke spread from internal fires	This includes fire spread from internal fires via the interface of the main structure with the façade (e.g. façade / slab interface), via concealed spaces / or combustibles within the façade itself and fire spread between floors due to flame extension over the façade.	3
Fire spread to adjacent structures	This includes calculation of exposure as a result of the façade becoming involved in a fire as well as from radiant heat and flames projecting from openings if a fully developed fire occurs. Fire spread to existing and future structures may need to be considered.	4

1.4 Guideline format

As described above this guideline dedicates a section to each of the three fire main scenarios. Each section has a similar layout and consists of the following five topics:

1. An overview and general description of the fire scenario.
2. Data, reasoning and references which may be used in the selection of design fires for the analysis and calculation methods which may be used to estimate the resulting actions from these fires.
3. Methods to determine the performance of the external façade when exposed to the design fire using calculation methods.
4. Methods to determine the performance of the external façade when exposed to the design fire using intermediate scale or full scale test methods.
5. Selection of acceptance criteria and how it can be shown in the analysis that the system meets, or does not meet, these criteria. Numerical acceptance criteria are not given as it is the responsibility of the Fire Safety Engineer and approval authorities to determine specific acceptance criteria and performance requirements within the local regulatory and project specific context.

2 Fire spread from external fire sources

2.1 Overview

Fire can spread to the subject building from an external fire source. Common sources of fire exposure to the external façade of a building include:

- Large hazards such as vehicles in close proximity.
- Intermediate hazards including fires originating from waste containers stored externally, collected debris external to the building, barbecues close to the building, etc.
- Smaller hazards such as embers, fire brands and burning debris impinging on the building
- Adjacent Structures including potential future developments.

The relevant hazards may be determined based on one or a combination of: a review of fire statistics, site inspection to determine the likely mix of combustibles that may contribute to an external fire and a Delphi approach during the Fire Engineers Brief process. The Delphi approach is an iterative process where a group of experts provide their opinions anonymously in a series of rounds and then revise their opinions following the end of each round where the other experts' opinions are revealed. The aim of using the approach is to result in a consensus being reached that reflects the experts combined knowledge and opinions.

Depending upon the proximity of the fire source the façade may be exposed to full flame engulfment for a sustained period, intermittent flame contact and radiant heat, or just radiant heat with potential embers providing a small ignition source.

The external fire source may spread fire by one or more of these three modes:

- Fire spread through the fabric of the external wall.
- Fire spread through openings in the external wall, such as windows.
- Fire spread to the combustible external façade which may lead to fire spread via one of the two methods identified above.

2.2 Applied actions and design fires

Sections 2.2.1 to 2.2.4 below provide guidance on selecting credible design fires for use in the analysis by the Fire Safety Engineer. These sections detail large hazards, intermediate hazards, small hazards and hazards from adjacent structures.

The large and intermediate hazards are very site specific and can be minimised by maintenance, policy procedures and suitable design of the subject building. These sub-systems could reduce the likelihood of or severity of the intermediate hazards. Site specific details should be accounted for when determining the likely intermediate and large fire sources.

Section 2.2.5 provides a method for converting the heat release rate of a design fire adjacent to an external wall to an estimated heat flux incident on the external wall. Section 2.2.6 provides a method for estimating the radiant heat flux received by the subject building from an adjacent building fire (existing building or future building) or other fire (such as a vehicle fire). The methods require the design fire to be defined.

2.2.1 Large hazards

Large hazards such as vehicles may result in a severe fire which may or not expose the façade to flame impingement. In the case of direct flame impingement the method given in section 2.2.5 can be used to estimate the heat flux received by the façade.

Test data relating to the specific hazard including measurements of heat release rate, heat flux and /or temperatures at critical locations should be used wherever possible. Other sources which may provide an indication of the heat release rate of large fires include the following.

- Section 3, Chapter 1, “Heat Release Rates”, SFPE Handbook of Fire Protection Engineering, 3rd edition, 2002.
- Profil ARBED Recherches, Development of Design Rules for Steel Structures Subjected to Natural Fires in Closed Car Parks, 1997.
- NIST, report of test FR4010, Scotch Pine Christmas Tree Fire Tests, 1991
- Table 1 of K. Opstad and J.P. Stensaas, FIRE MITIGATION MEASURES, Safe & Reliable Tunnels, Innovative European Achievements, 2006
- Ingason, Haukur, Gustavson, Soren, and Dahlberg, Martin. Heat Release Rate Measurements in Tunnels, BRANDFORSK project 723-924. SP, Swedish National Testing and Research Institute, Sweden, (1994)

2.2.2 Intermediate hazards

Intermediate hazards may include fires originating from waste containers stored externally, collected debris external to the building and barbeques close to the building.

Test data relating to the specific hazard including measurements of heat release rate, heat flux and/or temperatures at critical locations should be used wherever possible. Other sources which provide an indication of the heat release rate of large fires include the following.

- The NIST Experiment Results Website - <http://www.fire.nist.gov/fire/fires/>
- Report of Test FR4018, Heat Release Rate Tests of Plastic Trash Containers, NIST, 2003
- Section 3, Chapter 1, “Heat Release Rates”, SFPE Handbook of Fire Protection Engineering, 3rd edition, 2002.

A crude estimate of the heat release rate profile of an intermediate fire can be based on the energy content of the combustibles and an assumed maximum heat release rate and growth rate.

2.2.3 Smaller hazards

Smaller and lower risk hazards such as embers and fire brands from fires which are remote from the subject building should also be considered. However these hazards are not normally a significant risk by themselves and should be considered in conjunction with other actions such as radiant heat from adjacent structures (refer section 2.2.4).

2.2.4 Adjacent Structures

Potential fire exposures from adjacent buildings should be considered because a fire in an adjacent building may expose the subject building to high levels of radiant heat and embers / burning brands may provide ignition sources. Both existing structures and potential future developments should be considered.

Existing structures

Based on the design and use of the adjacent building one or more credible radiant heat exposure scenarios can be derived which considers criteria such as: expected fire severity in adjacent building; expected extent of fire (fire compartmentation) in adjacent building; and, location of openings in adjacent building relative to subject building and combustibility of materials forming the façade.

If the details of the adjacent building are well known the compartment fire temperature can be estimated based on parametric fire curves, such as those in EN 1991-1-2⁴, and the window openings can be considered as a radiant heat source at this temperature and with an emissivity of unity. The radiation from the flames projecting from a window can be compensated for by increasing the area of openings in the calculation by 20%⁵.

An alternative method is to assign a radiation intensity to the openings the adjacent building for use in the calculations. 84 kW/m² is considered to be a credible level of radiation intensity at openings in an office, residential or assembly building and 168 kW/m² is considered credible for commercial, industrial and storage buildings in Approved Document B⁶ from the UK. This method does not require the predicted compartment temperature to be calculated in order to calculate the radiation intensity at the compartment opening.

The number of openings in the adjacent building which can be considered to pose a simultaneous risk of radiant heat exposure to the subject building depends on active and passive fire safety systems of the adjacent building. However, it is considered conservative to the model an entire fire compartment as being involved in the fire and therefore all openings in that fire compartment may be imposing radiant heat on the subject building, subject to that opening having a line-of-sight from the building to the facade in question.

Future developments

Fire spread from future developments on adjacent allotments should also be considered. A “fictional building” can be considered which is constructed in compliance with current building regulations. The likely zoning of adjacent allotments should be considered in the design of this fictional building. Typical openings and compartmentation can be assumed in the fictional building and then the radiant heat flux calculations can be carried out in a similar way as for the case of existing buildings. In some studies a mirror image of the subject building is considered.

The National Construction Code Series⁷ addresses this issue in a different way by providing verification methods CV1 and CV2. The verification methods specify incident radiant heat fluxes that the subject building must withstand based on the distance from an allotment boundary or adjacent buildings. If this approach is adopted the “assumed heat flux” is considered incident on the subject building regardless of the details of the fictional building. Similarly, if it is shown that the building does not cause heat fluxes in excess of those in CV1 and CV2 on the adjacent property it is shown that the design meets the relevant performance requirements (refer section 4.5)

Table 2 – NCC CV1 and CV2 heat fluxes

Distance to boundary (m)	Distance to adjacent building (m)	Assumed Heat flux (kW/m²)
0	0	80
1	2	40
3	6	20
6	12	10

⁴ Eurocode 1: Actions on structures - Part 1-2: General actions - Actions on structures exposed to fire, EN-1991-1-2:2002, CEN, 2002

⁵ Carlsson, Emil. External Fire-spread to Adjoining Buildings - A review of fire safety design guidance and related research. Report 5051. Department of Fire Safety Engineering, Lund

⁶ Approved Document B, Volume 1, Department for Communities and Local Government, Government of the United Kingdom, 2006

⁷ National Construction Code Series, Australian Building Codes Board, 2011

2.2.5 Flame contact / exposure check and calculations

Based on the heat release rate (HRR) of a fire adjacent to an external wall the peak heat flux from the flame incident on the wall can be approximated by the following equations. This method is appropriate for intermediate and large hazards immediately adjacent to the external wall and the equations should be used within the limitations stated in the original work⁸.

The peak heat flux is given by:

$$q''_{\text{peak}} = 200[1 - \exp(-0.09Q^{1/3})]$$

The flame height can be approximated using:

$$L_f = 0.23Q^{2/5} - 1.02D$$

The heat fluxes at heights above the fire can be calculated via the following equations.

$$q''_{cl} = q''_{\text{peak}} \quad z/L_f \leq 0.4$$

$$q''_{cl} = q''_{\text{peak}} - \frac{5}{3}(z/L_f - 2/5)(q''_{\text{peak}} - 20) \quad 0.4 < z/L_f \leq 1.0$$

$$q''_{cl} = 20(z/L_f)^{-5/3} \quad z/L_f > 1.0$$

Where:

q''_{peak} = peak heat flux at wall (kW/m²)

q''_{cl} = heat flux at wall (kW/m²)

Q = heat release rate of fire (kW)

L_f = flame length (m)

D = size of fire (m)

z = height above fire source (m)

Based on the above equations a heat flux versus height relationship can be calculated for a fire adjacent to an external wall if the heat release rate of the fire is known or can be estimated.

Note: For some solid fuel types the highest heat flux can occur adjacent to the fuel at the base of a façade where high heat fluxes can be maintained for considerably periods. If the fire source is in contact with the façade this localised heat flux can substantially exceed the heat flux from the flame calculated using the above method

2.2.6 Radiant heat exposure calculations

The radiation received by the subject building from an adjacent building or large hazard can be calculated based on the fire scenario (see sections 2.2.2 to 2.2.4) and standard radiation transfer equations. The radiant heat flux at a point can be calculated based on the source temperature, emissivity and the geometry (configuration factor).

⁸ Section 2, Chapter 14, Heat Fluxes from Fires to Surfaces, SFPE, Handbook of Fire Protection Engineering, 3rd Edition, 2002

If a prescribed radiation intensity at the openings in an adjacent building is used, as suggested by Approved Document B⁶ and described above, then the terms $\varepsilon(T_f^4 - T_r^4)$ in the equation below can be replaced with that value (i.e. 168 kW/m² or 84 kW/m²).

$$F = \sigma \theta \varepsilon (T_f^4 - T_r^4)$$

Where:

F = radiant heat intensity at receiver (kW/m²)

σ = Stefan Boltzmann constant

T_f = temperature of fire (kelvin)

T_r = temperature of receiver (can be taken as 293 kelvin)

ε = emissivity (can be taken as 1 for fires in adjacent buildings)

θ = the configuration factor

2.3 Determination of performance by calculation

Using the estimated heat flux incident on the façade the performance of the façade can be estimated based on calculation methods and comparison to known material properties where the materials are homogeneous and stable under fire conditions.

The duration of exposure required to ignite a combustible material under different exposure conditions can be estimated based on material properties. Sources such that provide data for time to ignition under different fire exposures for different materials include the following.

- Ignition Handbook, Vytenis Babrauskas, 2003.

These sources show that typically timber products are unlikely to undergo piloted ignition from a small ignition source if the incident heat flux is below 12 kW/m².

2.4 Determination of performance by tests

2.4.1 Radiant heat only

AS 1530.4⁹ Appendix B7 provides a test procedure for evaluating the resistance of full sized elements of construction exposed to radiant heat. The test procedure exposes a nominal 3 m x 3 m specimen to a radiant heat source of similar dimensions.

2.4.2 Full flame engulfment from large flaming sources

In these instances a practical approach is to define the exposure in terms of an equivalent fire resistance test period and select a product with an appropriate fire resistance level (FRL). The National Construction Code deemed-to-satisfy provisions adopt this approach by requiring walls (and openings in walls) within certain distances of a fire source feature (an adjacent building or allotment boundary) to have a specified minimum FRL. This approach however does not consider fire spread on the external surface of the wall.

⁹ AS 1530.4 , Method for fire tests on building materials, components and structures – Fire-resistance test of elements of construction, Standards Australia, 2005

2.4.3 Intermediate scale façade test for evaluation of fire spread over combustible materials

An intermediate scale test such as ISO-1385-1¹⁰ is appropriate to determine performance when exposed to an external fire. ISO 13785-1 is intended for screening purposes, comparative purposes or evaluation of a family of products. The test can be modified by the inclusion of appropriate instrumentation to gather data for the analysis and the fire source modified to better reflect project specific requirements and the design fires selected by the Fire Safety Engineer. The tested specimen should reflect the exterior wall assembly as it would be constructed in practice and details such as fire stops, joints and cavity barriers¹¹ should be included in the tested specimen if they are used in the external wall system in practice.

The test specimen consists of a re-entrant corner. The specimen should incorporate a vertical joint and a horizontal joint. The bottom edge of the specimen should be a typical window encasement. The dimension of the main façade and side façade are 1.1 m x 2.4 m and 0.6 m x 2.4 m. Surface temperature and heat flux measurements are taken, along with observations.

The fire source specified in the standard is a propane burner giving a heat output of 100 kW throughout the test; however an alternative fire source such as timber cribs may be more appropriate based on an analysis of the hazards the external wall may be exposed to and the selected design fires. The test may also be modified to expose the specimen to radiant heat co-incident with an ignition source.

The flame spread on the façade is measured by observations (visual record of propagation of flame front) and by thermocouples installed on the façade which indicate when the flame front reaches the thermocouple. A heat flux meter is placed above the specimen. Thermocouples can be included on the unexposed side of the specimen and will provide data relating to the temperature – time profile of the unexposed surfaces to determine horizontal fire spread. If the external wall has cavities thermocouples should be placed in the cavities to indicate fire spread within this area.

2.5 Typical performance criteria

Typically it will be necessary to show that a façade is (to the degree necessary):

- Resistant to horizontal fire spread through external wall fabric.
- Resistant to flame spread on external wall.
- Resistant to vertical fire spread through openings in external wall.

2.5.1 Resistance to horizontal fire spread through external wall fabric

The external wall fabric (bulk construction) should resist the spread of fire from the external fire source to the compartments within the building by providing an effective barrier to the spread of fire by convection, conduction and radiation or a combination of these.

It can be considered that for the wall to provide an effective barrier to the spread of fire it will need to maintain structural adequacy, integrity and insulation, in accordance with the failure criteria specified in standard fire resistance tests (e.g. AS1530.4). Other criteria for failure can also be used based on specific project requirements.

If ignition of the façade does not occur then the rate of rise of temperature of the internal surface can be estimated using standard heat transfer calculation procedures based on the heat flux incident on the façade from the design fires.

¹⁰ ISO 13785-1:2002, Reaction-to-fire tests for façade – Part 1: Intermediate-scale test, ISO, 2002

¹¹ Cavity barriers may be used in a building to reduce fire and smoke spread in walls, floors and other cavities. Cavity barriers should be constructed from non-combustible materials and can be installed in concealed spaces which may allow fire/smoke spread to improve the performance of the system when exposed to fire.

If ignition does occur calculations cannot reliably predict how quickly the inner surface temperature will rise and therefore the acceptability of the design cannot be readily determined by calculation methods and reliance will need to be placed on test data.

The test method (refer section 2.4) can be instrumented to provide data relating to the unexposed side and core temperature rises and can provide a more conclusive method to determine compliance with this acceptance criteria.

2.5.2 Resistance to flame spread on external wall

If the calculations or tests show that the external wall does not ignite this acceptance criteria can be considered to be met.

However it is to be expected that a combustible façade may ignite when exposed to flames from an external fire source or high levels of radiant heat and therefore the acceptance criteria may comprise limiting flame spread to the degree necessary. If the flame spread on the façade is rapidly self-propagating this is unlikely to be acceptable. Between the extremes of no ignition and rapid self-propagating flame spread there will be an acceptable extent of flame spread which will need to be determined on a case-by-case basis having regard for fire spread to adjacent properties and breaching of façade and allowing fire spread to the internal compartments.

The results of the intermediate scale test may be able to be used to assess compliance with this acceptance criterion by measuring vertical fire spread supplemented by observations and temperature data. The extent of vertical flame spread can be compared against the project specific objectives and requirements for limiting vertical by spread and the acceptability determined.

2.5.3 Resistance to vertical fire spread through openings in external wall

One of the weakest links in an external wall for the spread of fire to the inside is the window. When exposed to sufficiently high temperatures a window may crack and/or fall out. If the window remains intact the risk of fire spread to the room is reduced, primarily through three mechanisms:

- Radiation to the room is reduced
- Convective heat transfer to the interior is excluded.
- Embers are prevented from entering the room, which reduces the chances of piloted ignition.

Depending on the building type the windows may be openable in which case it is common to analyse a worse case where the window or door is open.

While the window is intact it can be considered that the radiant heat flux which passes through the window and is incident on the inside materials is the relevant acceptance criteria. To prevent fire spread this should not exceed the level that may cause un-piloted ignition of the materials inside the room. The duration of exposure required to ignite a combustible material under different exposure conditions can be estimated based on material properties. Sources that provide data for time to ignition under different fire exposures for different materials include the following:

- Ignition Handbook, Vytenis Babrauskas, 2003.

When a window unit breaks and loses integrity the materials behind the window may be exposed to radiative and convective heat as well as ignition sources such as flames, embers or fire brands. A level of heat flux from a fire that causes a window unit to break and lose integrity is also likely to cause fire spread through the broken window and therefore this can be considered another acceptance criterion; i.e. the heat flux must not cause the window unit to break and lose integrity.

There is a wide range of reported heat fluxes which a window may withstand without cracking or falling out depending upon, amongst other things, the type and thickness of glass, framing details, size and configuration, thermal shock and uniformity of heating. Other fire safety sub-systems such as external drenchers may also increase the levels of heat flux required to cause fire spread by this method.

In Australia there are a large number of glazing systems that have been subjected to AS 1530.8.1¹² tests for use in Bushfire applications. The test method only has a short exposure period but the method can be readily modified to increase the exposure period if necessary.

¹² AS 1530.8.1 , Methods for fire tests on building materials, components and structures - Tests on elements of construction for buildings exposed to simulated bushfire attack - Radiant heat and small flaming sources, Standards Australia, 2007

3 Fire and smoke spread from internal fires

3.1 Overview

An internal fully developed fire may develop in a compartment and spread within a building by modes involving the external wall / façade. Smoke may also spread from one compartment to another. The four modes of fire and smoke spread are:

- Between floors via external openings.
- Fire spread to the combustible external façade which may lead to fire spread via another method.
- Via concealed spaces within the external wall / façade.
- Between floors via openings between slabs and the façade.

3.2 Applied actions and design fires

Sections 3.2.1 to 3.2.4 below provide guidance on selecting a credible design fire for use in the analysis. All of the information given in these sections should be considered by the Fire Safety Engineer when deciding which fire scenarios will be used in the analysis as design fires. Internal fires can be characterized in three phases (refer Figure 3-1 below). These phases are:

- Fire growth phase.
- Fully developed phase.
- Decay phase.

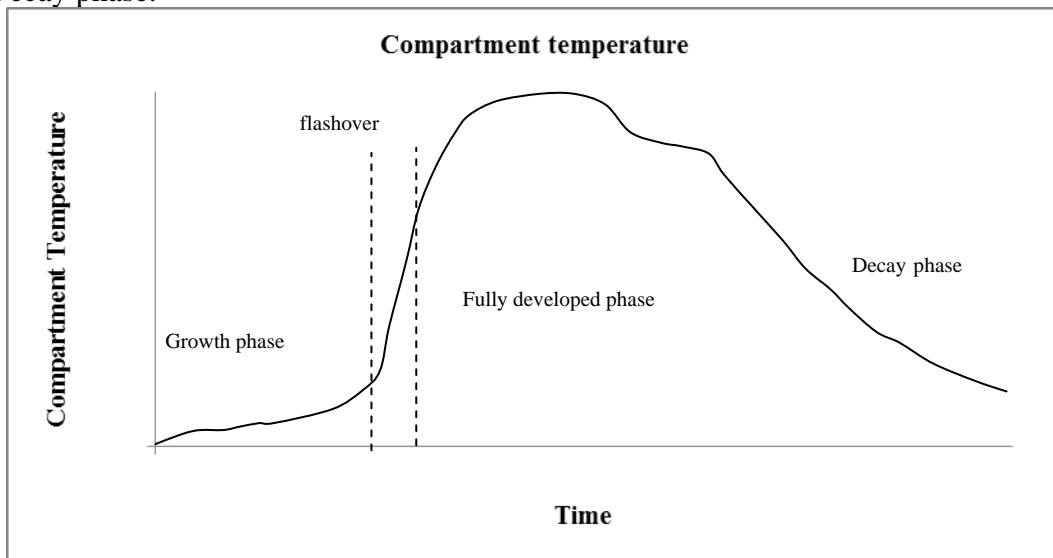

Figure 3-1 - Stages of a compartment fire which reaches flashover

During the growth phase the fuel configuration and ventilation conditions will control the fire growth rate and determine whether flashover could be achieved. It is during the growth stage that active fire safety systems such as sprinklers and occupant intervention are likely to be most effective. If either of these systems achieve their design objectives it is likely that the fire will be extinguished and not progress to a fully developed fire.

When considering fire spread between buildings and to some extent within buildings it is common to ignore the (time dependent) fire growth phase and focus on the fully developed phase of the fire. However if an analysis involves consideration of evacuation of building occupants the growth phase will need consideration because of the potential for evacuation paths to be compromised due to smoke spread. The size of a fire during the full developed phase is controlled by the available fuel (fuel controlled) or oxygen (ventilation controlled). If the fire is ventilation controlled flames will be ejected from the compartment to form an external fire plume. This fire plume may expose the

external wall above the window opening to high levels of heat flux. In many scenarios a fully developed fire will initially be ventilation controlled but will then transition to fuel controlled. Maximum enclosure temperatures will occur close to stoichiometric conditions (approximately the time of transition from ventilation to fuel controlled conditions) but the risk of external fire spread due to external flames leapfrogging fire barriers is normally greatest whilst the fire is ventilation controlled.

The decay phase occurs at some stage after the temperatures in the fire enclosure have peaked. Commonly the transition to the decay phase is considered to occur when the temperatures are below a nominated percentage of the maximum mean enclosure temperature (e.g. 80%). Section 3.2.1 provides some information which may help the Fire Safety Engineer determine a suitable fire load for use in the analysis. Section 3.2.2 outlines the effect ventilation may have on a fire and 3.2.4 provides methods for estimating the compartment temperature.

Section 3.2.4 provides a method for calculating the equivalent fire severity of a compartment fire. Section 3.2.5 provides a method for estimating the external flame height and heat flux incident on a façade from a ventilation controlled fire venting out a window.

3.2.1 Fire load

The fire load represents the quantity of combustibles in a compartment which may contribute to a fire. Sources of data to help determine the likely fire load in a compartment based on the expected use include:

- Chapter 3.4, Fire Loads, International Fire Engineering Guidelines, ABCB, 2005.
- Appendix C of Fire Code Reform Centre Report 99-03, 1999.
- EN1991-1-2:2002 Eurocode 1: Actions on structures, Part 1-2 (Annex E), 2002.

The sources generally give an average fire load and a standard deviation for a selection of occupancies. It is the responsibility of the Fire Safety Engineer to decide the appropriate fire load for use in the design in consultation with stakeholders / authorities during the FEB phase.

Characteristics of the fire load can have a significant impact on the risk of external fire spread. For example modern buildings contain high volumes of plastics which can produce volatiles at a higher rate than cellulosic materials during the early stages of a fully developed fire, resulting in greater flame extension from the fire enclosure and increased risk of external fire spread.

3.2.2 Ventilation

The ventilation opening size determines the oxygen available for combustion within the fire compartment.

When considering external fire spread reducing the size of flames expelled from the enclosure can have a significant impact on the risk of external fire spread. Therefore large openings sufficient to maintain fuel controlled burning conditions during a fully developed fire could be a useful design consideration for some buildings.

The geometry of a window can also have a significant effect of the characteristics of the flames projecting from a compartment fire.

3.2.3 Time-Temperature correlations

The temperature within a compartment during a fire can be estimated based on a variety of methods. The Fire Safety Engineer must satisfy themselves that the chosen method is appropriate and

the method is used within its limitations. These methods should also estimate the duration of the fire. Some methods include:

- Swedish fire curves (Magnusson & Thelandersson 1970).
- SFPE Standard on Calculating Fire Exposures to Structures.
- EN1991-1-2:2002 Eurocode 1: Actions on structures, Part 1-2 (Annex A), CEN, 2002.

Compartment temperatures can critically affect the performance of fire stopping at the perimeter of a floor (i.e. at the junction between floors and external walls) as well as the performance of the bounding construction.

3.2.4 Fire severity calculations

Compartment fires have a different temperature-time profile to the standard fire curve (refer Appendix B.4 for an example) however sometimes it is useful to express the severity of a compartment fire as the equivalent duration of exposure to the standard fire curve.

The CIB W14 method provides a method to estimate the equivalent fire severity of a compartment based on the fire load, dimensions of the room and construction of the room. This should be used to estimate the equivalent fire severity that the bounding construction of the compartment will be exposed to.

3.2.5 External fire plume calculations

There are a variety of methods available to estimate the height of and heat flux from an external fire plume venting out of a window. The most appropriate method should be chosen by the Fire Safety Engineer with consideration given to the required accuracy, available time and intended use of the results. Some methods include:

- Law and Thomas's method for flame height
- Buchannan's method.
- Oleszkiewicz's Method.
- The EN-1991-1-2 (Annex B) method.
- Computational fluid dynamics (e.g. FDS).

Features such as balconies can be incorporated into the design as these may decrease the heat flux incident on the façade.

The empirically derived calculation methods described above (Law and Thomas's method, Buchannan's method, Oleszkiewicz's Method and the EN-1991-1-2 (Annex B) method) can be used to estimate the heat flux incident on the façade of an external wall. However these methods should be used within their field of application and can be considered approximate.

Computational Fluid Dynamics CFD models can also be used to predict the heat flux imposed on an external wall from enclosures but care must be taken to ensure the inputs are appropriate and results are verified against experimental data.

3.3 Determination of performance by calculation

3.3.1 Elements and combinations of elements exposed to a fully developed fire in a compartment

The performance of building façade elements and combinations of elements may need to be evaluated when exposed to a fully developed fire. The estimated temperature-time profile in the compartment or equivalent fire severity of the compartment (FRL) can be used to estimate the

performance of elements of construction. For example the concept of equivalent fire severity can be used to convert the fire exposure into an equivalent FRL period which can be used for specification purposes.

The performance of the junction between the external wall and the floor slab (and internal walls) needs to be established for many designs. If, for example an unprotected aluminium system is used with non-combustible fire stopping at junctions it is difficult to accurately predict the forces these components may impose on each other and it is therefore difficult to estimate the response to a real compartment fire. In these instances reliance may need to be placed on specific test data that applies to the specific form of construction (refer section 3.4)

3.3.2 External elements or combinations of elements exposed to radiant heat and / or flames from a fully developed fire

As discussed in section 2.3 the heat flux and duration required to ignite a combustible material can be estimated based on material properties and compared against the estimated fire exposure from the design fire. If the material ignites the rate of fire spread needs to be determined, which can be complex for some assemblies. The heat flux incident on the window openings can be estimated however, as discussed in section 2.5.3 the reaction of the window assembly cannot be accurately predicted and the total heat flux cannot be calculated easily if the façade material ignites and contributes to the total heat release rate.

Empirically derived calculation methods and computer modelling techniques can in some instances be used to estimate the actions from the fire and the resulting temperatures and heat fluxes which may be produced. However these methods should be used within their field of application. For example it is possible to estimate the impact of these fire hazards on materials such as concrete with well-known thermal and mechanical properties at elevated temperatures but composites, combustible materials and materials such as cement sheet that may deteriorate when exposed to elevated temperatures may require supplementary data.

3.4 Determination of performance by tests

Whilst there are a number of large scale test methods for evaluation of the resistance of external fire façades exposed to fire conditions ISO 13785-2¹³ has a number of advantages in addition to being the appropriate international standard.

It is a full scale test method that can be adapted to evaluate most aspects of a façade simultaneously (refer dot points below) and give a realistic end-use assessment of performance.

The four identified modes of fire spread are (refer section 3.1):

- Between floors via external openings.
- Fire spread to the combustible external façade which may lead to fire spread via another method.
- Via non-fire stopped concealed spaces within the external wall.
- Between floors via inadequately protected openings between slabs and the façade.

The test method uses a similar re-entrant corner design as the intermediate scale test (refer section 2.4) with a 4 m x 4 m x 2 m burn room with a 1.2 m x 2.0 m opening. The main façade and side façade are a minimum of 3 m wide and 1.2 m wide, respectively. The height of façade is a minimum of 4 m above the top of the window opening. A diagram of the overall test setup is shown in Figure 3-2 below.

¹³ ISO 13785-2:2002, Reaction-to-fire tests for façade – Part 2: Full scale test, ISO, 2002.

The re-entrant corner is considered to produce a worst case scenario for self-propagating flame spread on a combustible external wall, refer to Appendix A for further information.

The method can be readily adapted to evaluate different fuel loads opening sizes, balconies slab interface details etc. and other design features enabling it to be adapted for a specific façade system and building as well as offering a standard test procedure for the assessment of façades. The Fire Safety Engineer must be satisfied that the tested system (including fire loads, room geometry, opening geometry, wall systems, junctions between systems etc) are representative of the design in practice or they can be taken into account by supplementary analysis

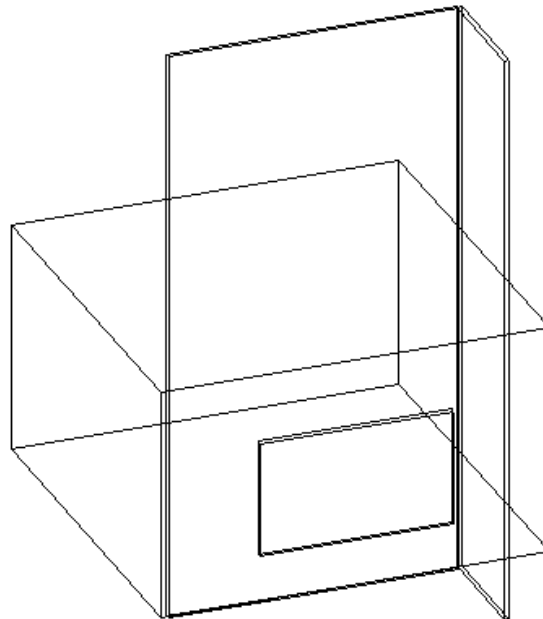

Figure 3-2 - Diagram of ISO 13785-2 Test Facility

3.5 Typical performance criteria

Typically it will be necessary to show that a façade is (to the degree necessary):

- Resistant to fire spread between floors via external openings.
- Resistant to fire spread between floors due to fire spread across a combustible external façade.
- Resistant to fire spread via non-fire stopped concealed spaces within the external wall.
- Resistant to fire spread between floors via openings between slabs and the external wall.

3.5.1 Resistance to fire spread between floors via external openings.

A window or opening may be exposed to high heat fluxes from a fire plume venting out of a lower window and the combustibles within a compartment above the fire compartment may be ignited. Some risk of fire spread by this mode (“leapfrogging”) is commonly accepted by building codes (i.e. by requiring spandrels only 900 mm deep) but experiments such as those in Appendix B show that under certain circumstances fire spread will still occur.

A fire engineering study will need to address this issue by either preventing fire spread between floors by other means or acknowledging the risk of fire spread but determining that the risk to life is acceptable by, for example, expanding the study to show that all occupants have the opportunity to evacuate and fire fighters are not placed at unnecessary risk.

3.5.2 Resistance to fire spread between floors due to fire spread across a combustible external façade

The combustible façade may ignite from flames venting from a compartment fire and lead to self-propagating fire spread or increase the heat flux incident on openings above.

Calculation or test methods can predict if an external façade is likely to ignite and if ignition does occur tests such as ISO 13785-2 can be used to demonstrate whether burning of a façade is self-propagating and if leapfrogging is likely to occur.

The approach suggested in 3.5.1 may be suitable if leapfrogging (fire spread between floors) is likely to occur.

3.5.3 Resistance to fire spread via non-fire stopped concealed spaces.

Fire can spread within concealed spaces of external wall system and allow the fire to re-enter into the building at a higher level. This risk may be addressed through the use of appropriate cavity barriers the efficacy of which can be demonstrated through tests such as ISO 13785-2 however if adequate barriers cannot be provided the acceptance criteria would need to be developed to address specific issues relating to fire in a concealed space such as incipient fire spread, rapid acceleration and spread and fire fighting difficulties.

3.5.4 Resistance to fire spread between floors via openings between floors and the external wall

The detailing of the junction between the external wall system and the building fabric should not allow fire spread to adjacent compartments, to the degree necessary. An equivalent fire severity of a fully developed internal fire can be estimated and compared to the FRL of barriers and perimeter detailing, however this may not accurately reflect the response of a structure and often perimeter detailing can fall out of place and allow hot gases to pass when exposed to fire conditions. Where this risk is identified the adaptation of ISO 13785-2 described in Appendix A can be employed. Acceptance criteria may limit temperature rises to 180 K, require no through gaps to form or apply a cotton wool pad test as defined in AS 1530.4 to judge resistance to flame spread.

4 Fire spread to adjacent structures

4.1 Overview

Fire can spread from the subject building to adjacent buildings by modes involving the external wall/façade. A fully developed fire within the subject building or a fire involving a combustible external wall/façade may expose an adjacent building to radiant heat co-incident with small ignition hazards such as embers or fire brands.

4.2 Applied actions and design fires

The primary design fire which may cause fire spread to an adjacent building is a fully developed compartment fire in the subject building. Three sources of radiant heat from a compartment fire are identified and discussed in the following subsections. These sources are:

- Openings in the compartment.
- External flames venting out of the compartment.
- Contribution from combustible cladding.

4.2.1 Compartment fire and external flames

Compartment fires in the subject building and external flames from the subject building are discussed in section 3.2 of this document. Refer to the previous sections of this document for more information relating to compartment fires and external fire plumes.

4.2.2 Contribution from façade material

When a combustible façade is involved in the fire it will increase the radiation received by the adjacent building. If the façade does not ignite when exposed to the design fire the radiation from the façade should not be considered; however if the façade material does ignite it will increase the radiation received by an adjacent building and should therefore be considered.

4.3 Determination of performance by calculation

Section 3 provides information which may help in determining if a fully developed fire will cause an external wall/façade material to ignite. If the external wall/façade material does not ignite the radiation transmitted to an adjacent property can be calculated using the methods described in section 2.2 and section 2.3.

If the façade material does ignite the level of radiation from the façade cannot be readily calculated and test methods should be used to better determine the performance of the system.

4.4 Determination of performance by tests

The radiant heat imposed on an adjacent building can be measured experimentally using the ISO 13785-2 test method described in section 3.4 and Appendix A. An array of radiometers should be placed at various locations away from the façade where radiation is desired to be measured. This method will consider all aspects of the design that may transmit radiation to adjacent buildings and allotments and is considered more accurate than calculations methods.

4.5 Typical performance criteria

Typically it will be necessary to show that a façade does not expose adjacent property to unacceptable levels of radiant heat.

The limits of acceptable radiant heat levels imposed on adjacent properties may be given in the building regulations. For example, CV1 and CV2 in the National Construction Code provide

guidance on the limiting heat flux that a building may impose on an adjacent building. These values are based on 20 kw/m^2 being the radiation required for piloted ignition of timber.

Table 3 - Heat flux values from CV1 and CV2

Distance to boundary (m)	Distance to adjacent building (m)	Acceptable limit of heat flux imposed (kw/m2)
0	0	80
1	2	40
3	6	20
6	12	10

Other building codes may have different values of acceptable heat flux.

The specific acceptance criteria should be developed in conjunction with the approval authority.

5 Acknowledgements

The authors wish to thank the Timber Development Association (NSW) for providing assistance and the Forest & Wood Products Australia (FWPA) for providing funding to undertake this work.

Appendix A Full scale test method (ISO 13785-2)

A.1 Introduction

This section details the ISO 13785-2:2002 *Reaction-to-fire tests for façades – Part 2: Large-scale test method*¹⁴ and specific modifications to the test method that may be used by a Fire Safety Engineer to determine the performance of an external wall/façade system.

A.2 ISO 13785-2 method

The test method assesses the behaviour of an external wall façade or cladding system when exposed to flames venting through a window opening. This section provides a summary of the test method and for more information the ISO 13785-2 standard should be referred to in full.

The test facility consists of a compartment with an opening in one of the walls and vertical façade extending above this opening. The vertical façade consists of a main façade and a side façade. A diagram of a typical test facility used for this test is shown in the figure below.

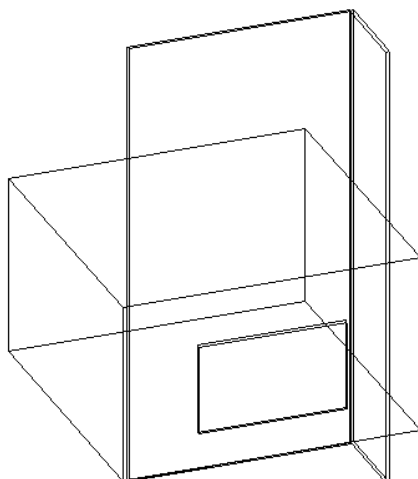

Figure A.1 – Diagram of full scale test setup

The compartment dimensions are not specified in the standard but the volume is restricted to the range of 20 m³ to 100 m³. The compartment should have only one opening in the main façade of dimensions 2.0 m wide by 1.2 m high.

The standard states that propane is the standard source of fuel however other fuels can be used and guidance on wood and liquid fuel sources is provided. The facility should be calibrated to expose the façade to (55 ± 5) kW/m², 0.6 m above the window opening and (35 ± 5) kW/m² 1.6 m above the window opening for a duration of 15 minutes. Including ramp up and ramp down times the duration of test is specified as between 23 and 27 minutes.

The standard requires that the test specimen is installed in accordance with the manufacturer's instructions and is representative of the façade system used in practice. The window opening is to be as in end use practice. The specimen is to incorporate vertical joints and horizontal joints if these are normally incorporated into the system.

¹⁴ ISO 13785-2:2002, Reaction-to-fire tests for façade – Part 2: Full scale test, ISO, 2002.

The façade is instrumented with thermocouples and heat flux meters at various locations. A total of 8 heat flux meters are required to measure the heat fluxes at various points on the façade. A minimum of 7 thermocouples are required to measure the temperatures at various points on the façade. Additional thermocouples are required at each layer at a height of 4 m if the wall system consists of multiple layers.

There are no failure criteria specified in the standard, but the test can provide data for a Fire Safety Engineer to analyse and use to support an external wall design. Data which may be of use include measured heat flux above the specimen and surface temperatures. These measurements can provide a basis for estimating vertical flame spread and the contribution of the external wall to vertical flame spread. Observations may also be taken which may be used to qualitatively assess the flame spread and falling debris hazards of the external wall. The test methods may be adapted for use in specific projects by tailoring the fire exposure to the hazards identified for the project. Acceptance criteria may also form part of the Fire Engineering Brief and Fire Engineering Report process which is recommended by the International Fire Engineering Guidelines.

A.3 Test modifications

The test method that can be adapted to evaluate most aspects of a façade simultaneously and can be tailored to project specific requirements where the end-use of the product is well known.

It is the responsibility of the Fire Safety Engineer to satisfy themselves that the test modifications are valid and appropriate.

A.3.1 Fire load, ventilation and façade exposure

The standard specifies a heat flux the façade should be exposed to and does not consider that different occupancies and building designs may be exposed to different levels of heat flux.

The fire scenario can be based on the actual design and use of the building/project. It may be appropriate to use a fire load which consists of timber cribs with the mass of timber cribs chosen dependent on a percentile value of findings from fire load surveys for the type of occupancy being investigated. Similarly, the window size and compartment size can be modified to better reflect typical compartments of that occupancy.

This will give fire characteristics and exposure to the external wall that is typical of that occupancy and these modifications can be made on a project basis.

A.3.2 Façade details modification

The standard does not consider internal fire spread via the external wall, i.e. fire spread via gaps at the external wall and the floor. However, the standard can easily be adapted to include this aspect. The adaption requires the specific details to be constructed as well as additional instrumentation to be installed.

A.3.3 Window details modification

The breakage of glazing is not well predicted using calculation methods and therefore should be included in the test when possible. A complete glazing unit can be installed into the façade system at an appropriate height above the window opening. This will allow the glazing unit's

performance to the fire exposure to be determined. Additional instrumentation can be supplied to measure the radiation behind the glazing unit and other characteristics which may indicate its performance.

A.3.4 Radiation to adjacent buildings

Radiometers can be placed at critical distances from the main façade to measure the radiation transmitted by the fully developed fire to these points. An array of radiometers should be placed at various locations away from the façade where radiation is desired to be measured. This method will consider all aspects of the design that may transmit radiation to adjacent buildings and allotments and is considered more accurate than calculations methods.

Appendix B Report of full scale tests

B.1 Introduction

This section reports the results of full scale tests which were carried out by Exova Warringtonfire. The tests were intended to represent a typical fire in a non-sprinklered hotel building with a high fire load.

Two similar room enclosures and façades were constructed in general accordance with ISO 13785-2. One room was constructed with timber framing and the other with steel framing. Both enclosures were lined with fire rated plasterboard to achieve the same nominal FRL of 90/90/90. The rooms had the dimensions 4 m x 4 m x 2.4 m.

An external façade of nominal height 6 m and a side façade of the same height were present on the external face of the fire room, extending above the fire room opening. The façades were similar except that a 0.6 m horizontal projection was fitted to the façade for one of the tests. The horizontal projection was 0.5 m above the top of the window opening. The test with the projection is termed the “balcony test” and the test without the projection is termed the “control test”.

B.2 Fire load

The fire load of the test compartment was chosen to be 41 kg/m² (kg wood per m² floor area) which equates to approximately 740 MJ/m² based on a heat of combustion of 18 MJ/kg. This fire load was based on the 95th percentile figures of fire loads in hotel room from a literature review. The fire load was timber cribs and the total mass of cribs in each experiment was 656 kg.

B.3 Ventilation

An opening of 2 m width x 1.2 m height was located in the centre of the front wall with the sill at a height of 0.5 m above the floor. This was considered typical of hotel windows.

B.4 Time-temperature correlations

Temperature measurements were taken within each compartment and are given Figure B.1 below. The standard fire curve, hydrocarbon fire curve and the parametric fire curve derived from EN1991-1-2 methods are also shown on the graph (these curves are delayed to account for the incipient phase of the fire).

It can be seen that the measured compartment temperatures are similar which indicates a level of repeatability of the experiments and insensitivity to framing construction (timber framed and steel framed).

The measured temperatures exceeded the standard fire curve for approximately 30 minutes and then reduced as the fuel was consumed and the fire entered the decay phase.

The parametric fire curve is a closer approximation to the measured compartment temperatures than the standard fire curve; however it still overestimates the duration of the fire. The parametric fire curve described in EN1991-1-2 Annex A is based on the work of Wickstrom and does not well represent situations where combustibles may burn outside the compartment. The method is better suited to modelling burning conditions that are

stoichiometric and this may explain why the length of the fully developed fire is over predicted by the parametric curve.

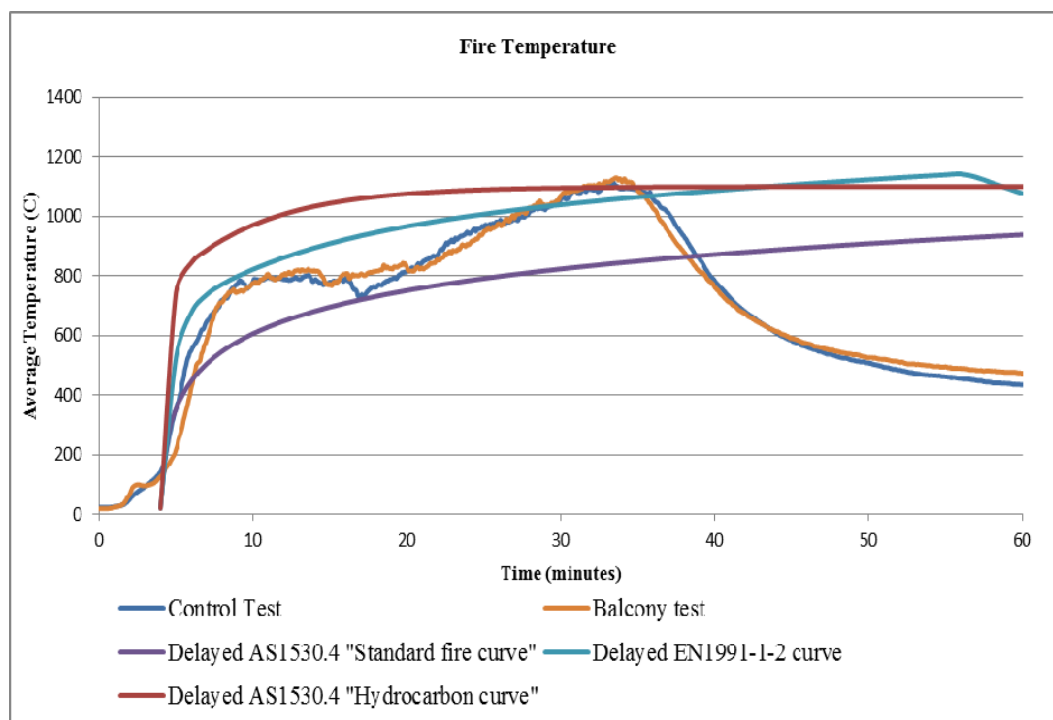

Figure B.1 – Measured compartment fire temperature and standard fire temperatures

B.5 Fire severity calculations

The fire load chosen for the experiments gives an estimated equivalent fire exposure of 61 minutes using the International Council for Research & Innovation in Building & Construction Working Commission 14 (CIB W14) calculation method.

B.6 External fire plume

Flame Height

Law and Thomas developed a widely used empirical model for external flame dimensions. In their model the flame has a constant cross section from the opening to the tip of the flame. Based on Law and Thomas's methods the estimated flame height for the flames venting out of the compartment during the test can be estimated to be 4.2 m (simple mass burning rate) or 2.4 m (more complex mass burning rate).

The actual flame height observed during the control test varied with time however reached a peak of approximately 4.5 m above the top of the window opening. The flames from the balcony test reached a similar peak, however were generally slightly (~0.5 m) below those observed in the control test.

Heat Flux

The heat flux on the external wall at various heights above the opening was measured using heat flux meters. It can be seen in Figure B.2 and Figure B.3 below that during the control test the peak heat fluxes 1.5 m above the top of the window exceeded 130 kW/m² while during the balcony test it slightly exceeded 100 kW/m². The peak heat flux at 3 m above the top of

the window exceeded 50 kW/m^2 , high enough to ignite many combustible materials and a level which may cause non-fire rated windows to fail and allow fire spread inside.

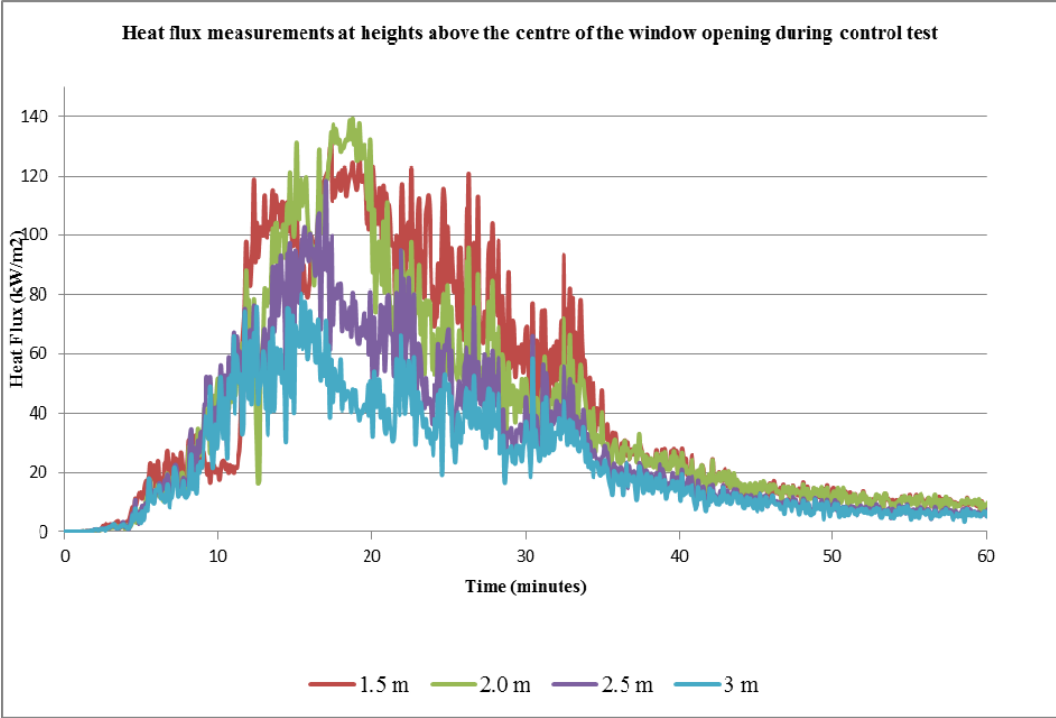

Figure B.2 –Heat flux measurements at heights above the centre of the window during the control test

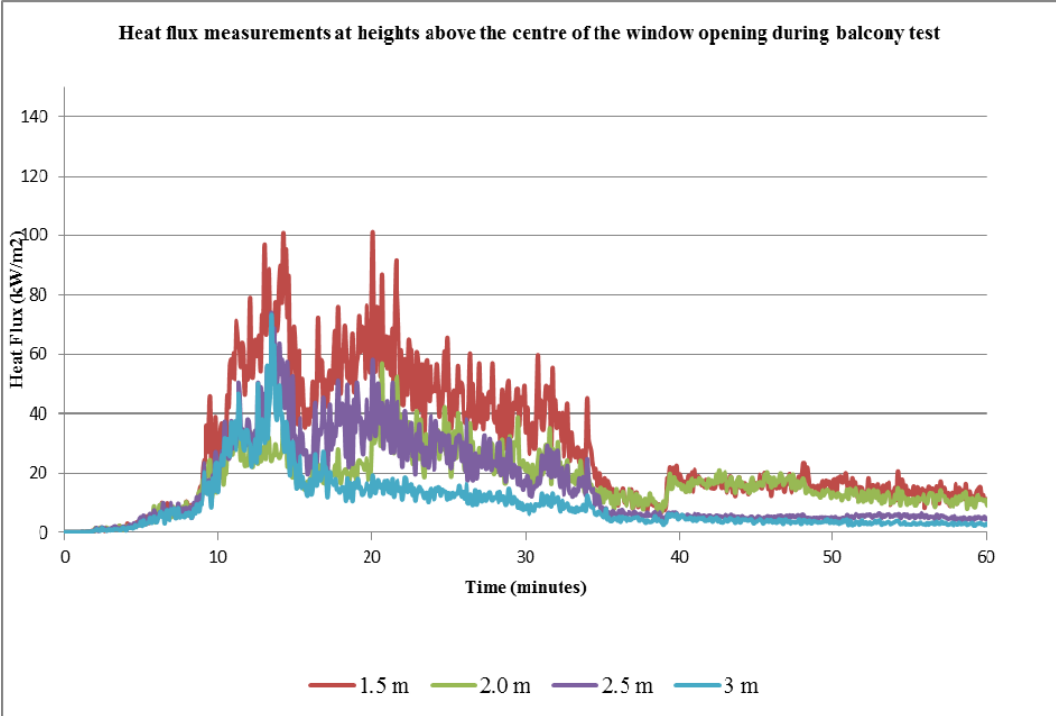

Figure B.3 –Heat flux measurements at heights above the centre of the window during the balcony test

Effect on heat flux of balcony

A comparison of a 2 minute moving average between the control test and the balcony test is shown for heights of 1.5 m and 3 m above the window opening in Figure B.4 below. It can be seen that the reduction in heat flux is significant at both 1.5 m above the top of the window opening and 3 m above the top of the window opening. This can be attributed to the balcony projecting the flame away from the façade face. During the test the balcony lost integrity and removed itself from the façade at approximately 40 minutes into the test.

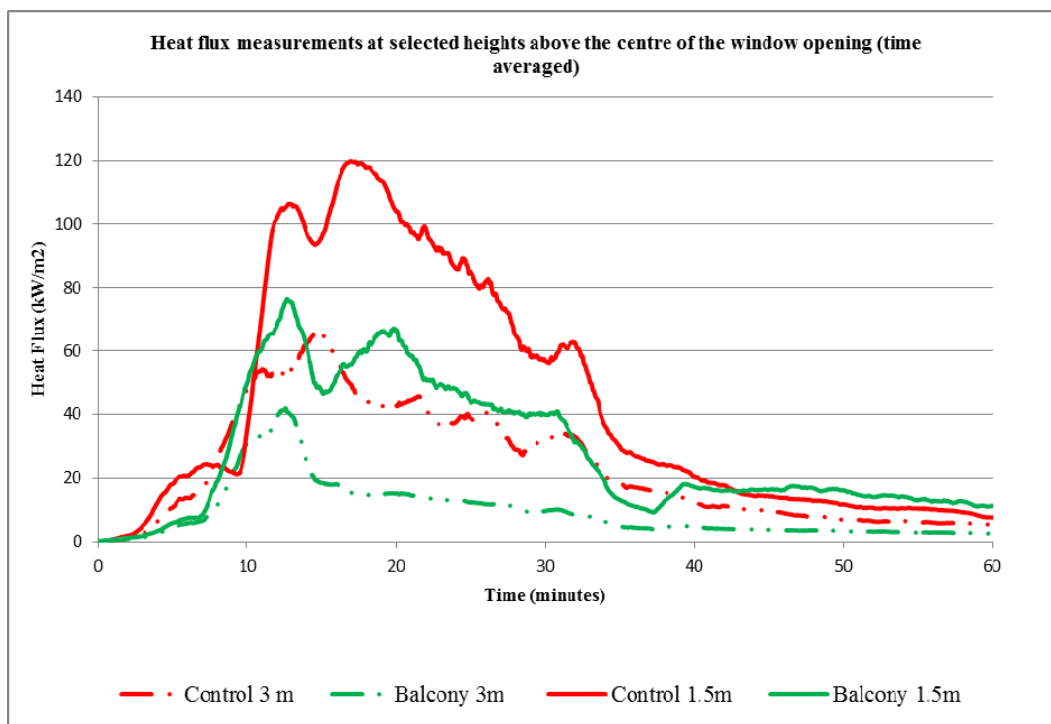

Figure B.4 –Comparison of heat flux measurements at selected heights above the window opening

Fire plume temperatures

The measured temperature of the fire plume at heights of 50 mm, 1.0 m, 1.5 m, 2.0, 2.5 m, 3.0 m and 3.5 m above the top of the window opening are compared in the seven figures below (Figure B.5 to Figure B.11). These measurements were taken immediately adjacent to the external wall.

It can be seen that the measured temperatures were generally lower for the balcony test when compared with the control test; except the temperatures 50 mm above the window opening (below the horizontal projection) were similar for both tests.

The balcony collapsed approximately 39 minutes into the test and this resulted in a sudden rise in measured temperatures on the façade in the balcony test at this time. It can be seen that after the balcony collapsed the temperatures were similar for both tests.

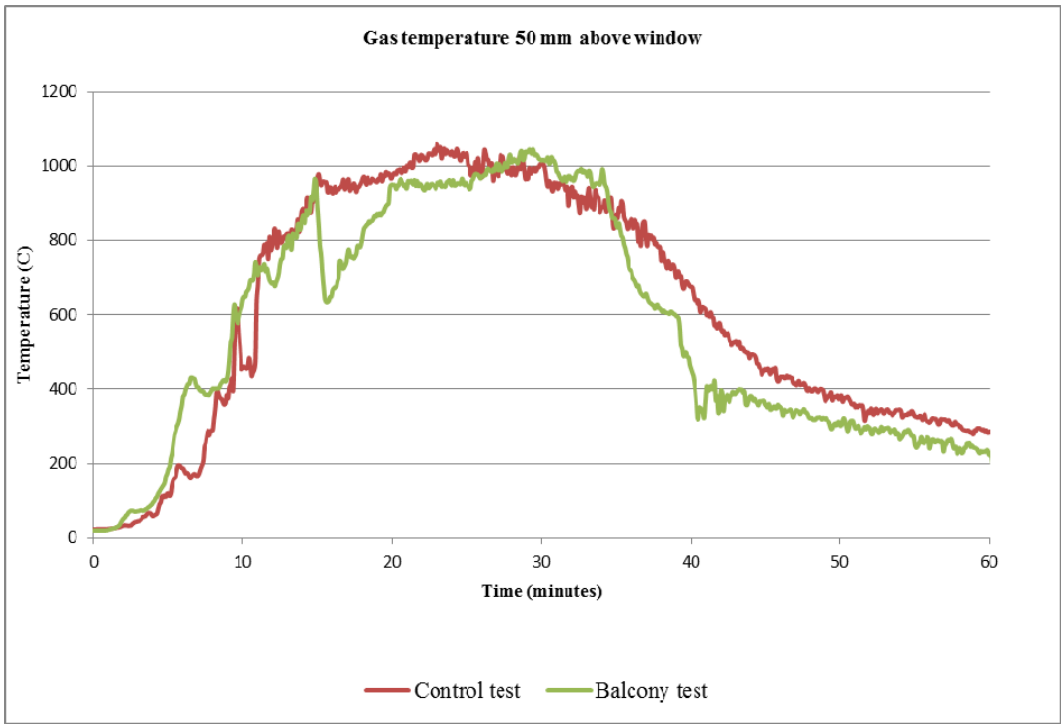

Figure B.5 –Gas temperature at 50 mm above window opening

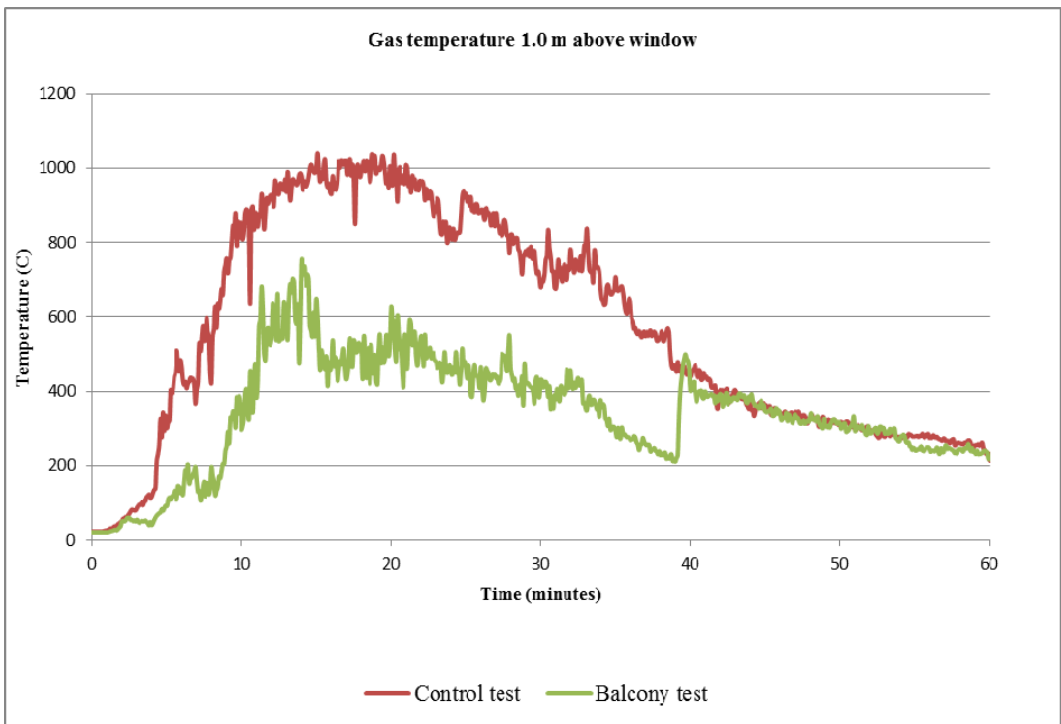

Figure B.6 –Gas temperature at 1.0 m above window opening

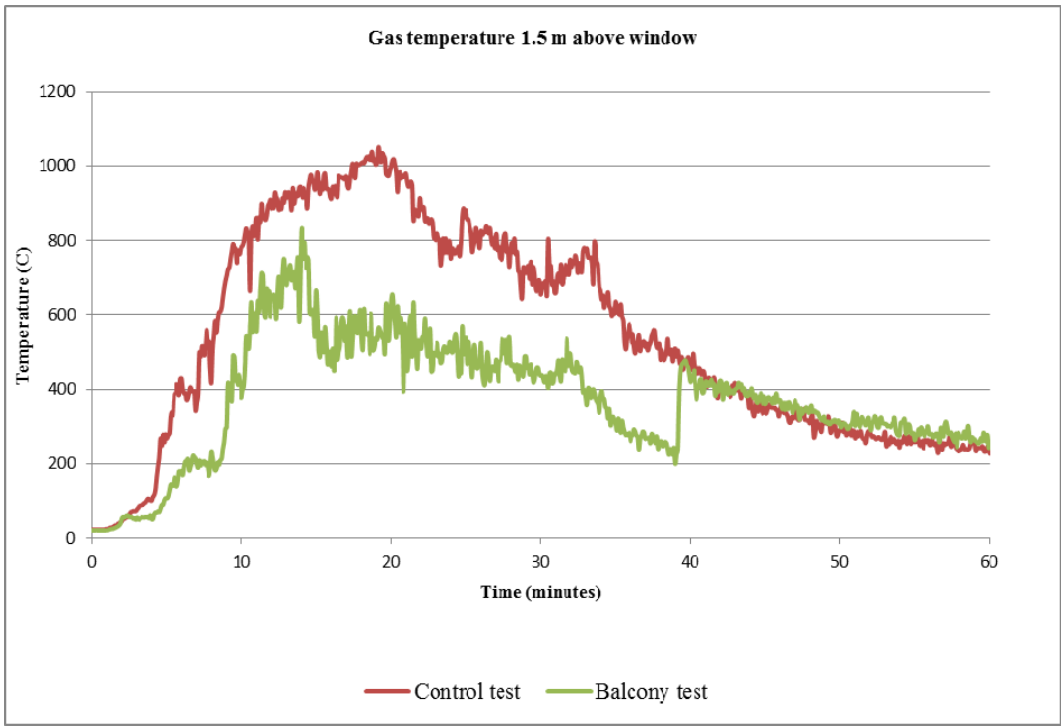

Figure B.7 –Gas temperature at 1.5 m above window opening

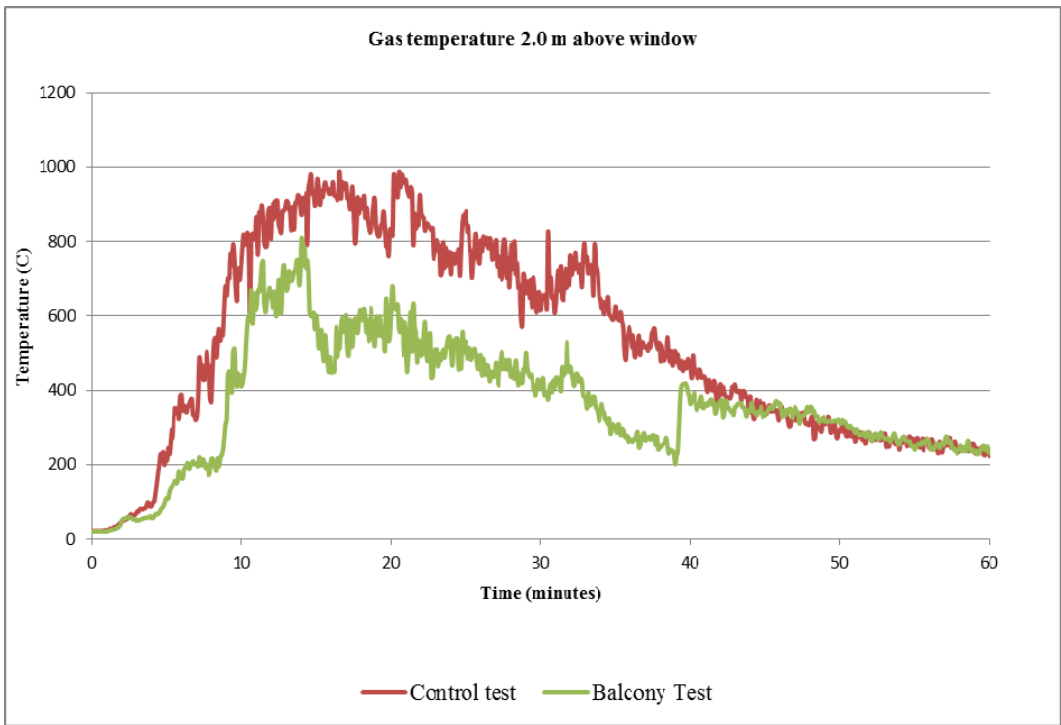

Figure B.8 –Gas temperature at 2.0 m above window opening

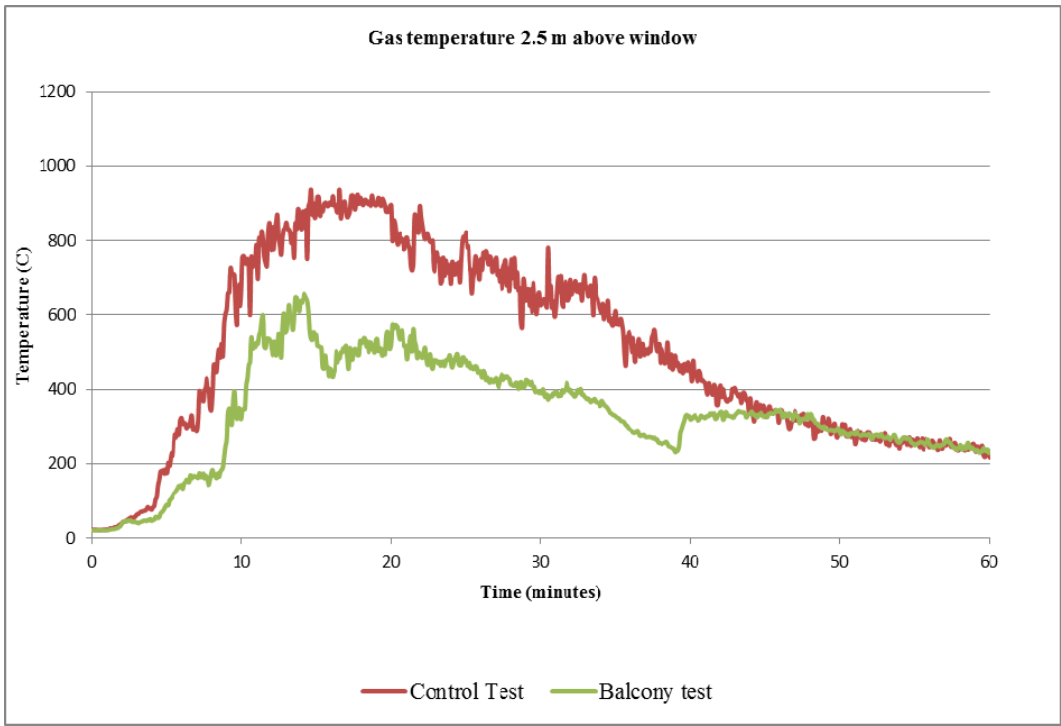

Figure B.9 –Gas temperature at 2.5 m above window opening

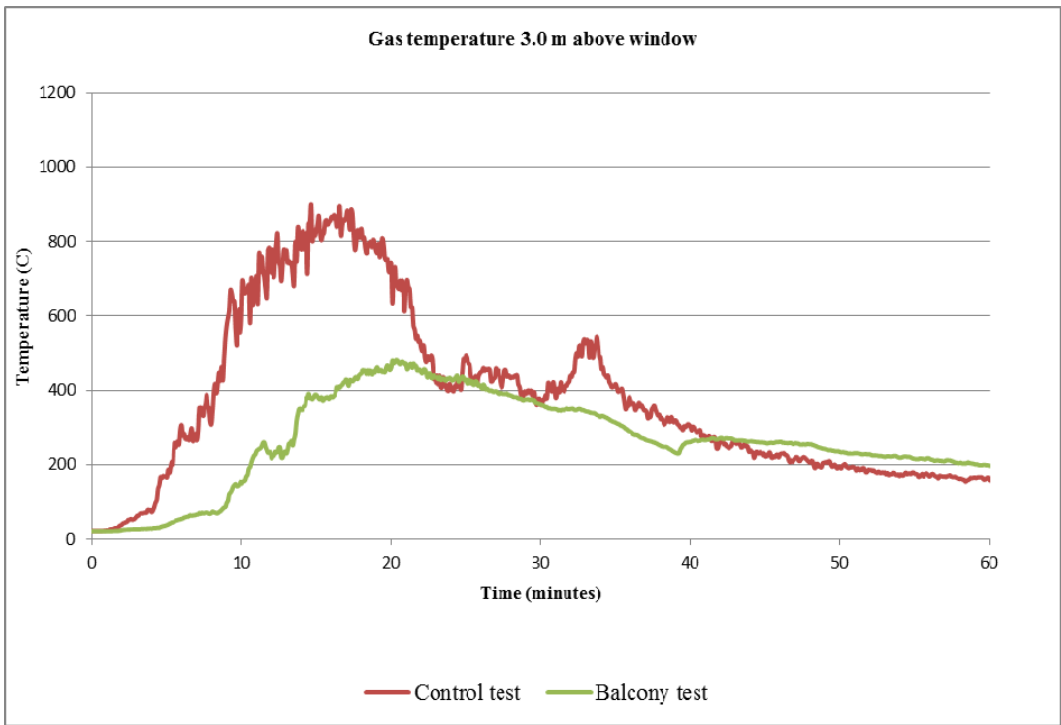

Figure B.10 –Gas temperature at 3.0 m above window opening

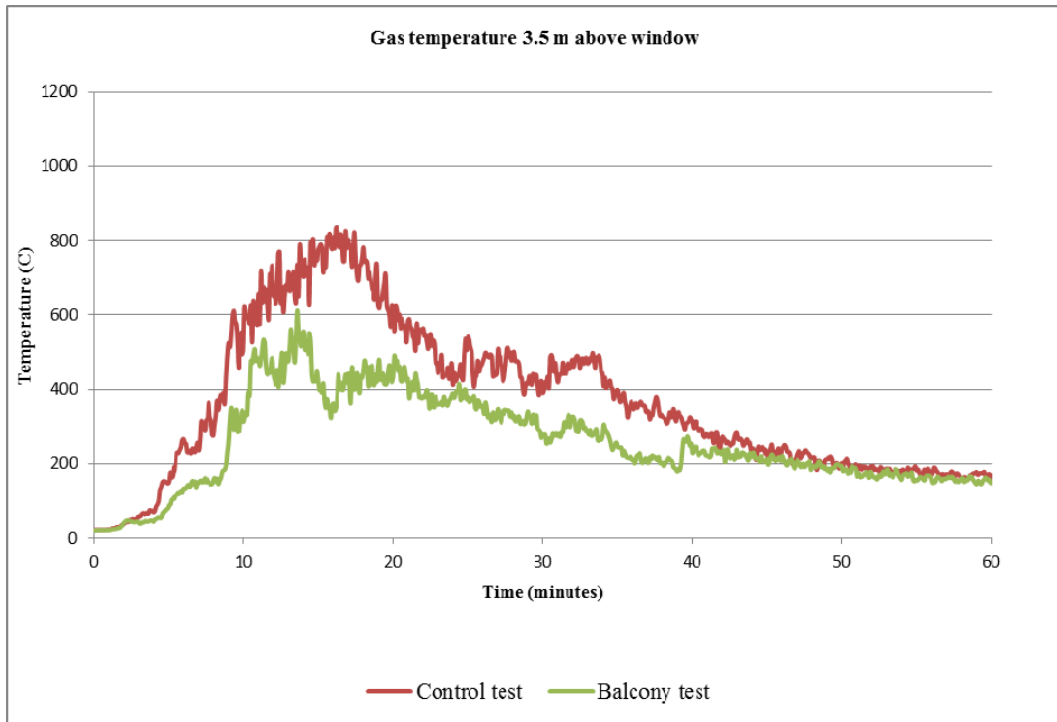
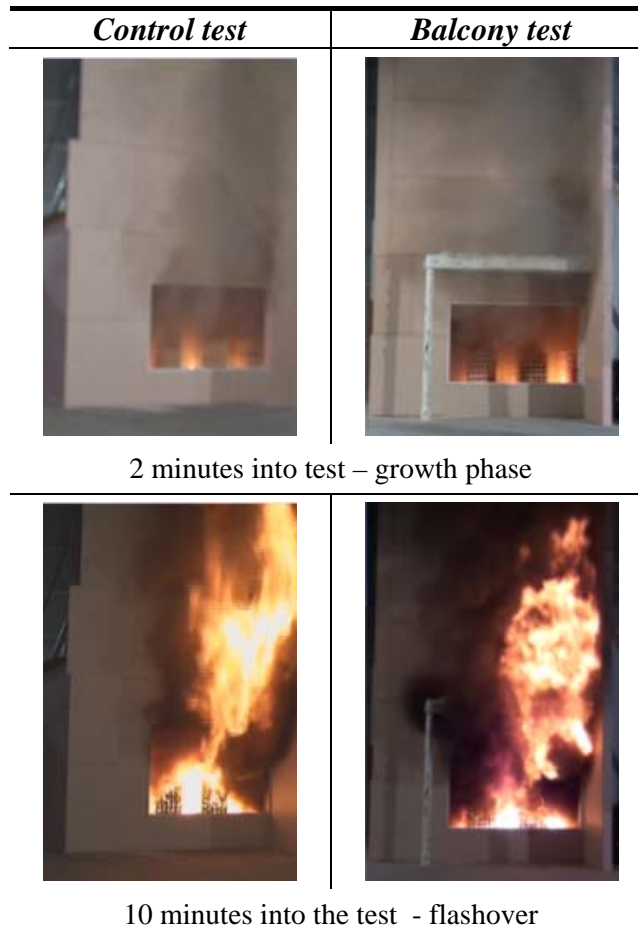

Figure B.11 –Gas temperature at 3.5 m above window opening

B.8 Burning regimes

The growth phase of the burning started when the timber cribs were ignited and lasted until approximately 10 minutes into the test. At approximately 10 minutes flashover occurred. Photos of the test taken at 2 minutes and 10 minutes are shown below.



During the post flashover phase a ventilation controlled burning regime was initially established with significant volumes of volatiles being expelled from the opening and burning outside the enclosure. This strongly ventilation controlled regime occurred from approximately 12 to 20 minutes and coincided with the maximum flame extensions outside the enclosures and maximum heat fluxes and temperatures adjacent to the façades. Photos of the test taken at 15 minutes and 20 minutes are shown below.

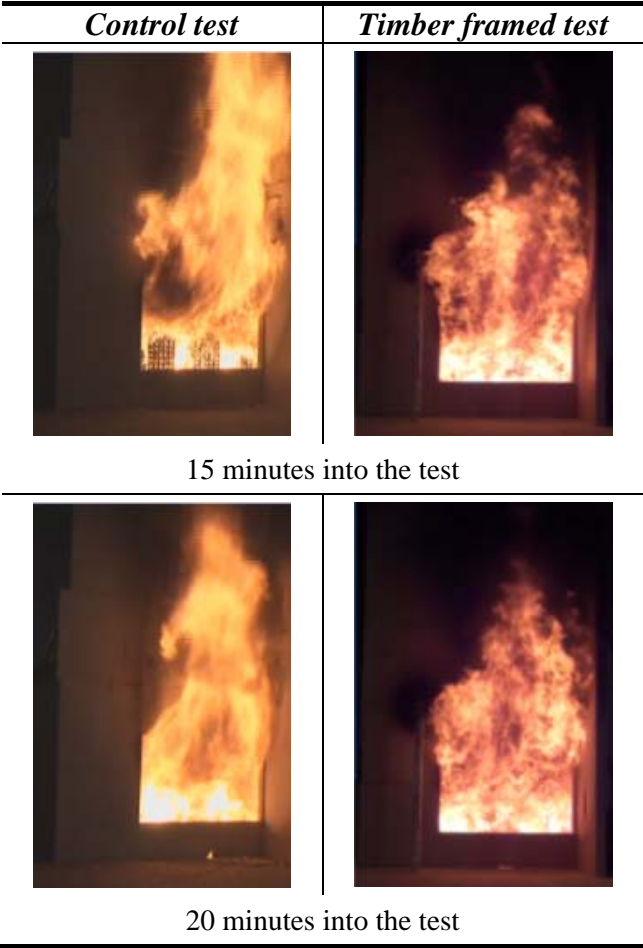

From 20 to 35 minutes of the tests the production of excess volatiles progressively reduced resulting in a corresponding reduction in the length of flames exiting the window and heat fluxes and temperatures adjacent to the façade whilst enclosure temperatures continued to increase.

At approximately 35 minutes the enclosure temperature peaked at 1100°C and flames and volatiles were no longer burning outside the enclosure to same extent as the before indicating that the burning regime approximated to stoichiometric conditions. Photos of the test taken at 35 minutes are shown below.

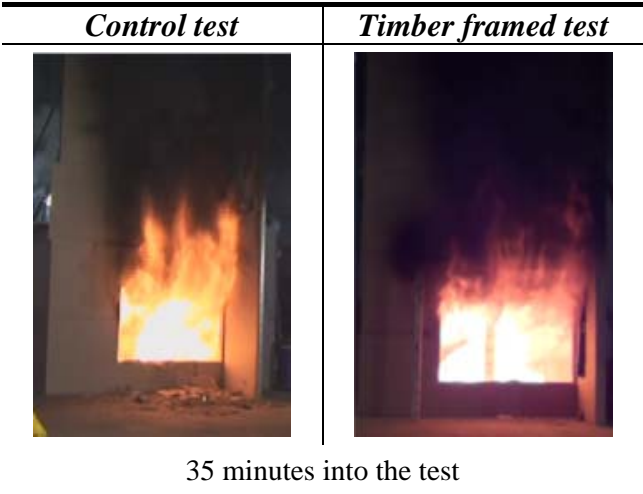

After 35 minutes of the test the burning regime was fuel controlled and temperatures within the enclosure progressively reduced to approximately 750°C after 40 minutes, 600°C after 45 minutes and 400°C after 50 minutes. Photos of the test taken at 40 minutes, 45 minutes and 50 minutes are shown below.

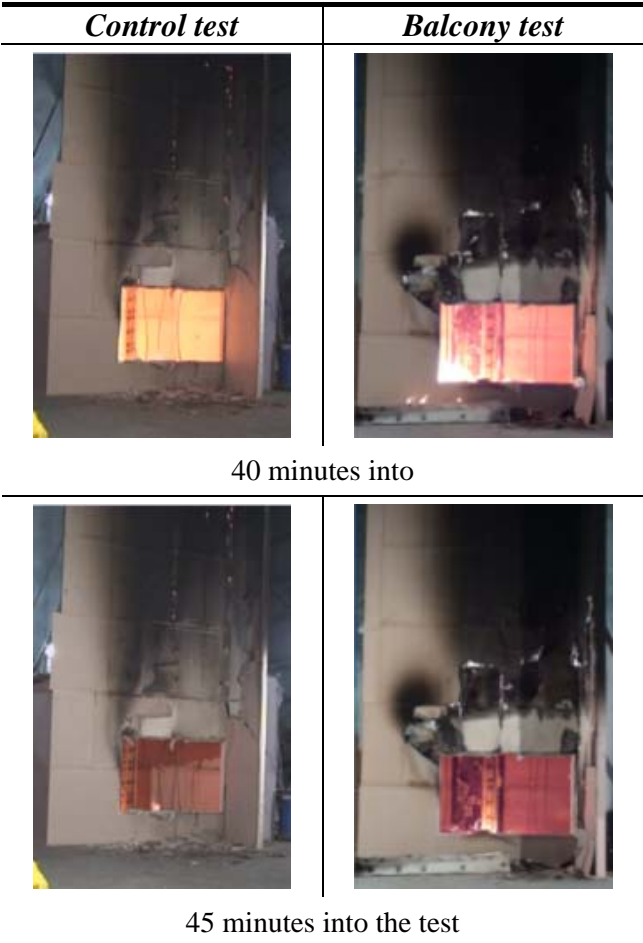



50 minutes into the test

The following table summarizes key measurements under the differing burning regimes. The heat flux readings are averaged over a two minute period.

<i>Test reference</i>	<i>Test time (minutes)</i>	<i>Burning regime</i>	<i>Enclosure Temp (°C)</i>	<i>Heat flux 1.5 m above opening (kW/m²)</i>	<i>Heat flux 3 m above opening (kW/m²)</i>	<i>Temp 1.5 m above opening (°C)</i>	<i>Temp 3.0 m above opening (°C)</i>
Control	2	Growth (fuel controlled)	50	2	1	46	39
Balcony			67	1	1	53	24
Control	20	Strong vent controlled	813	104	43	1000	741
Balcony			831	67	15	639	461
Control	28	Vent controlled	1018	65	29	777	433
Balcony			1029	41	11	467	386
Control	35	Stoichiometric (approximate)	1090	30	18	636	417
Balcony			1088	13	5	312	313
Control	40	Decay phase (fuel controlled)	785	20	12	467	303
Balcony (removed)			763	17	5	420	262

B.9 Discussion

The experiments were based on hotel rooms and a realistic fire load, compartment dimensions and compartment opening size were chosen. These parameters were used as inputs into calculation methods to estimate the compartment temperature, fire severity and fire plume height.

The calculation methods gave approximate results when compared to the experimental results. The parametric temperature calculation gave a good representation of the fire during the growth phase and fully developed phase however it over estimated the duration of the fully developed stage.

The predicted fire severity of 61 minutes was not compared against results from the standard fire curve however it was noted that the bounding construction with an FRL of 90 minutes did not fail during the test.

The flame height calculations were a close match to observed flame heights when the simpler method of calculation mass burning rate in Laws Method was used.

The heat flux incident on the façade was considerably reduced by the 0.6 m horizontal projection and was sensitive to the extent of ventilation control during the flashover phase. The temperature adjacent to the façade was also reduced substantially by the balcony / horizontal projection.